

## INTELLIGENT TOOL CONNECTIVITY

EBT comes supplied as standard with complimentary PC software "EvoLog" for data management and tool configuration. EBT also offers great flexibility in connection possibilities as it can be interfaced with third party production control software.

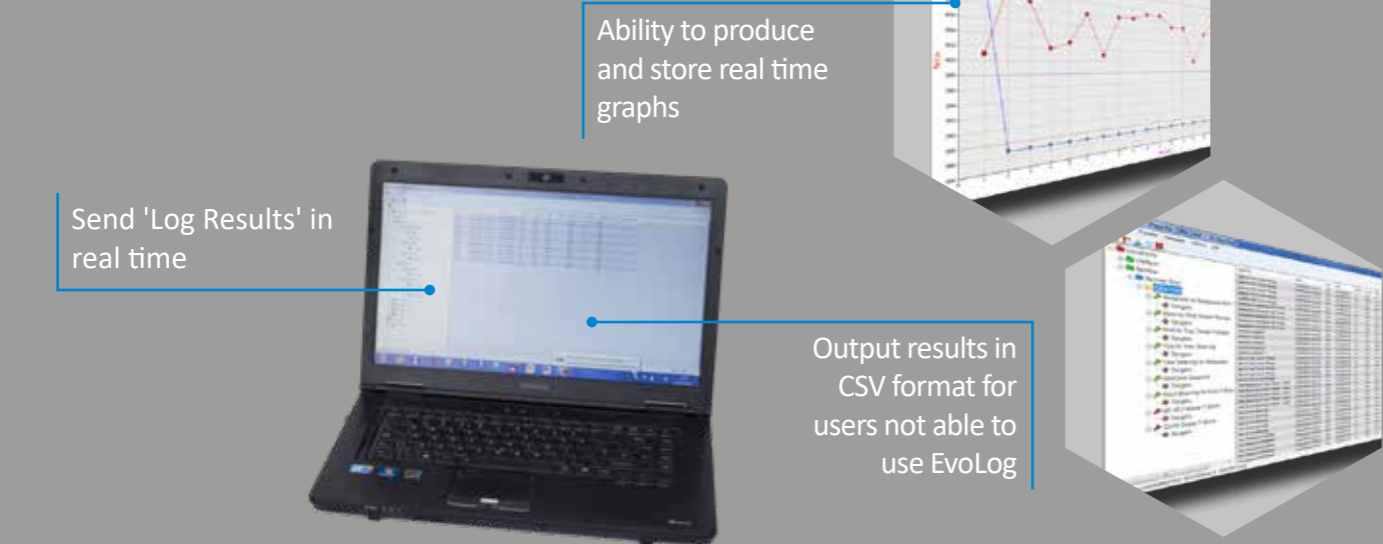

## ATTACHMENTS & ACCESSORIES

A wide range of attachments and accessories make EBT adaptable to suit many applications.

### Right Angle Gearbox

The Right Angle Gearbox will provide EBT tools with a 90° angle of operation, enabling the operator to reach more applications where access is restricted and limited

SAFE TO START KIT PART NUMBER	MODEL	SQUARE DRIVE	CALIBRATED RANGE	
			N-m	lbf-ft
180353	EBT-52-800 Right Angle	3/4"	160 - 800	118 - 600
180449	EBT-72-1350 Right Angle	3/4" & 1"	200 - 1,350	150 - 1,000
180473	EBT-72-1350 Auto 2 Speed Right Angle	3/4" & 1"	338 - 1,350	250 - 1,000
180545	EBT-80-2700 Right Angle	1"	400 - 2,700	295 - 2,000
180569	EBT-80-2700 Auto 2 Speed Right Angle	1"	676 - 2,700	499 - 2,000
180641	EBT-92-4000 Right Angle	1"	800 - 4,000	590 - 2,950
180665	EBT-92-4000 Auto 2 Speed Right Angle	1"	1,000 - 4,000	738 - 2,950

NOTE: Bare models also available, contact Norbar for details



Right Angle Gearbox (180280)



(60334.EBT)

EBT Battery Pack

A replacement lithium-Ion 18 Volts battery pack for use with the EBT. Two batteries come as standard with kit versions



(60335.KIT)

EBT Battery Charger

The EBT Battery Charger comes as standard with kit versions but can also be sold separately if desired

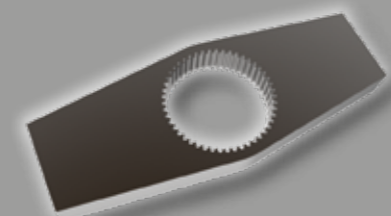

Reaction Plates

A variety of reaction plates and adaptors, together with ancillary feet, blades and heads are available to aid use. Contact Norbar for details

## GLOBAL SERVICE

Norbar is the only torque equipment manufacturer capable of offering tool and instrument calibration services to the original factory standard on four continents.

Accredited laboratories in Australia, USA, Singapore, China and India operate the same equipment and procedures as the UKAS accredited laboratory within our headquarters in the UK.

 NORBAR TORQUE TOOLS LTD  
Wildmere Road, Banbury, Oxfordshire, OX16 3JU  
UNITED KINGDOM  
Tel + 44 (0)1295 753600  
Email sales@norbar.com

 NORBAR TORQUE TOOLS  
45-47 Raglan Avenue, Edwardstown  
SA 5039  
AUSTRALIA  
Tel + 61 (0)8 8292 9777  
Email norbar@norbar.com.au

 NORBAR TORQUE TOOLS INC  
36400 Biltmore Place, Willoughby  
Ohio 44094  
USA  
Tel + 1 866 667 2272  
Email inquiry@norbar.us

 NORBAR TORQUE TOOLS  
c/o Snap-on Tools Singapore PTE LTD  
25 Tagore Lane #01-02  
SINGAPORE 787 602  
Tel + 65 6841 1371  
Email enquiries@norbar.sg

 NORBAR TORQUE TOOLS (SHANGHAI) LTD  
91 Building- 7F, No. 1122, North Qinzhou Road  
Xuhui District, Shanghai  
CHINA 201103  
Tel + 86 21 6145 0368  
Email sales@norbar.com.cn

 NORBAR TORQUE TOOLS INDIA PVT. LTD  
Plot No A – 168 Khairne Industrial Area  
Thane Belapur Road  
Mahape Navi Mumbai – 400 709  
INDIA  
Tel + 91 22 2778 8480  
Email enquiry@norbar.in

www.norbar.com



## NORBAR PRODUCT PORTFOLIO

-  Torque Screwdrivers
-  Torque Wrenches
-  Electronic Torque Wrenches
-  Manual Torque Multipliers
-  Pneumatic Torque Tools
-  Electronic Torque Tools
-  Battery Torque Tools
-  Torque Measurement Instruments
-  Torque Transducers
-  Ultrasonic Bolt Measurement
-  Calibration Services

Distributed by

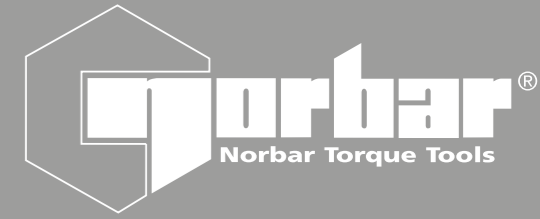

# EVOTORQUE® BATTERY TOOL

DRIVEN BY TECHNOLOGY, POWERED BY BATTERY,  
READY FOR INDUSTRY



THE EVOTORQUE® BATTERY TOOL (EBT) FEATURES A NEW BRUSHLESS MOTOR, DATA MEMORY AND DATA TRANSFER CAPABILITIES. NORBAR HAS COMBINED THIS WITH THEIR RESPECTED GEARBOXES TO DELIVER A RANGE OF FAST, RELIABLE AND ACCURATE BATTERY TORQUE TOOLS.

- Fast:** EBT uses a powerful motor coupled with either a single speed or auto two speed gearbox for rapid joint completion times.
- Durable:** The industrial motor used by the EBT gives long life with minimal motor service requirement.
- Accurate:** EBT is a transducer controlled battery powered torque tool designed for accurately applying torque to threaded fasteners. The unique 'intelligent joint sensing' technology continually measures the joint during tightening and when necessary, employs dynamic braking to avoid torque over-shoot due to motor inertia, consistently achieving highly accurate results of up to ±3% of setting.



180541  
EBT 2,700  
N-m Kit



When the tool is to be used for untightening bolts, Norbar recommends the selection of single speed versions  
In the case of prevailing torque lock-nuts or partially tightening bolts, the Auto Two Speed version of the tools will generally give no advantage and single speed tools should be selected

The square drive is quickly and easily replaceable

Robust steel reaction supplied as standard

Bespoke reactions available on request

Handle and trigger designed for optimum comfort

18V, 5.0Ah battery and efficient motor give outstanding fastening performance per charge

High powered LED to illuminate application

Accuracy up to ±3%

Brushless motor for low maintenance

OLED display ensures visibility in all conditions

'Safe to start' button ensures hands are safely positioned at start up

In some circumstances it can be difficult to support and operate the tool while simultaneously pressing the trigger and 'safe to start' button

For this reason, single trigger models are available

Key Lock feature prevents unauthorised usage

Kit tools are supplied with a Secondary Handle (19363 or 19448) for additional support and ease of handling (800 N-m tools do not come with a secondary handle)

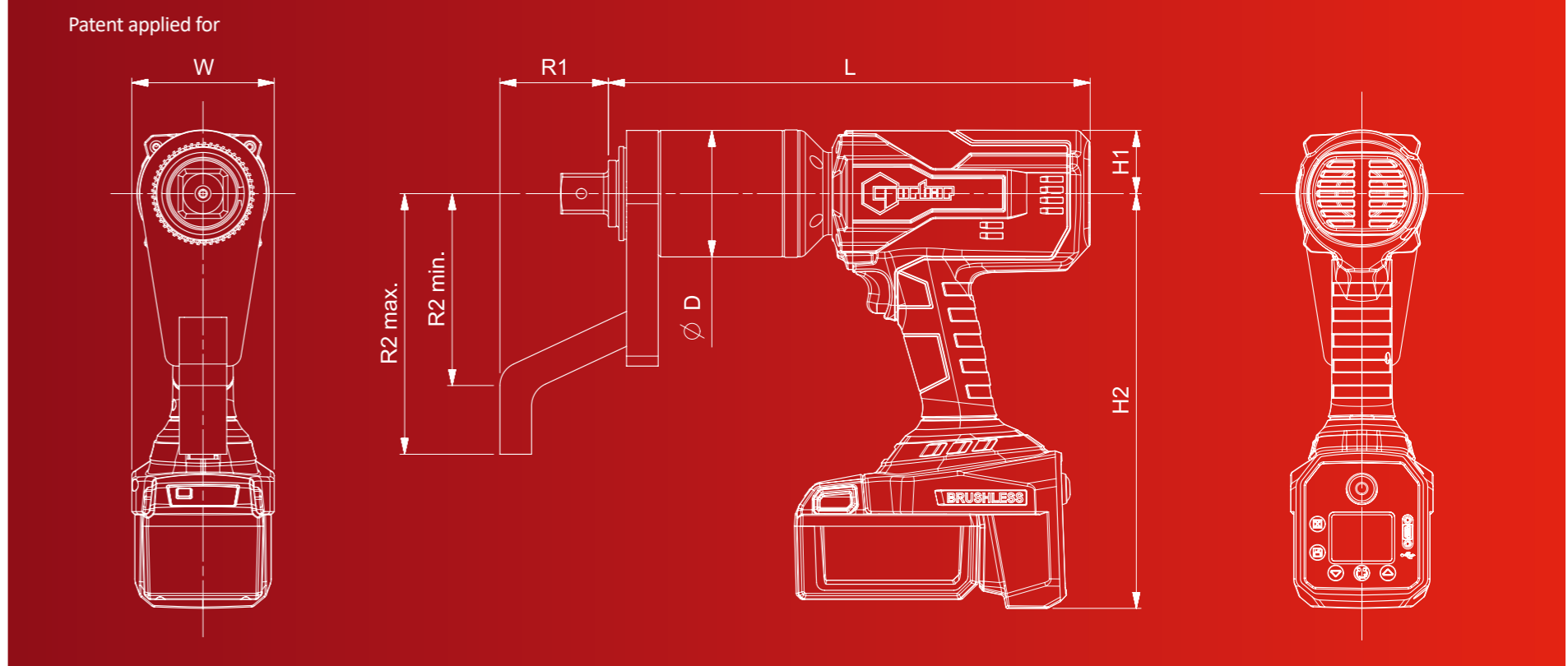

TECHNICAL SPECIFICATION

	KIT PART NUMBER	BARE PART NUMBER	MODEL	SQUARE DRIVE	CALIBRATED RANGE		DIMENSIONS (mm)						TOOL WEIGHT (kg) *	REACTION WEIGHT (kg)	OUTPUT SPEED (rpm)		
					N-m	lbf-ft	ØD max	H1	H2	L	R1	R2 min				R2 max	W
SAFE TO START MODELS	180349	180350	EBT-52-800	¾"	160 - 800	118 - 600	52	40	262	271	59	68	131	90	3.7	0.8	11.2
	180445	180446	EBT-72-1350	¾" & 1"	200 - 1,350	150 - 1,000	72	40	262	298	76	124	167	90	5.7	1.4	6.5
	180469	180470	EBT-72-1350 Auto 2 Speed	¾" & 1"	338 - 1,350	250 - 1,000	72	40	262	317	76	124	167	90	5.9	1.4	32
	180541	180542	EBT-80-2700	1"	400 - 2,700	295 - 2,000	80	40	262	298	76	124	167	90	5.9	1.4	3.3
	180565	180566	EBT-80-2700 Auto 2 Speed	1"	676 - 2,700	499 - 2,000	80	40	262	333	76	124	167	90	6.8	1.4	13
	180637	180638	EBT-92-4000	1"	800 - 4,000	590 - 2,950	92	40	262	352	70	125	175	90	7.9	2.5	2.3
SINGLE TRIGGER MODELS	180661	180662	EBT-92-4000 Auto 2 Speed	1"	1,000 - 4,000	738 - 2,950	92	40	262	387	70	125	175	90	8.3	2.5	9.5
	180850	180581	EBT-52-800	¾"	160 - 800	118 - 600	52	40	262	271	59	68	131	90	3.7	0.8	11.2
	180898	180899	EBT-72-1350	¾" & 1"	200 - 1,350	150 - 1,000	72	40	262	298	76	124	167	90	5.7	1.4	6.5
	180922	180923	EBT-72-1350 Auto 2 Speed	¾" & 1"	338 - 1,350	250 - 1,000	72	40	262	317	76	124	167	90	5.9	1.4	32
	180946	180947	EBT-80-2700	1"	400 - 2,700	295 - 2,000	80	40	262	298	76	124	167	90	5.9	1.4	3.3
	180970	180971	EBT-80-2700 Auto 2 Speed	1"	676 - 2,700	499 - 2,000	80	40	262	333	76	124	167	90	6.8	1.4	13
	180994	180995	EBT-92-4000	1"	800 - 4,000	590 - 2,950	92	40	262	352	70	125	175	90	7.9	2.5	2.3
	181018	181019	EBT-92-4000 Auto 2 Speed	1"	1,000 - 4,000	738 - 2,950	92	40	262	387	70	125	175	90	8.3	2.5	9.5

NOTE: Kit versions come with tool, 2 batteries, charger and a secondary handle in a carry case. 800 N-m tools do not come with a secondary handle. Bare tools are supplied in a cardboard box without batteries, charger and secondary handle. Other tool variations are available, please contact Norbar for details. \* Tool weight excludes both reaction and battery. The battery weighs 0.8 kg.

KEY FEATURES

- Tool is not constrained by power cable or hose, improving safety, convenience and versatility
- Multiple units of torque measurement, including N-m, lbf-ft and kgf-m
- Torque, Torque & Angle and Torque Audit modes available
- In Torque & Angle Mode and Audit Mode, torque can be set from a lower percentage of tool maximum on single speed tools compared to their auto two speed equivalents. Single speed tools are therefore recommended for angle operation
- 'Torque Only' mode provides the user with 'Ease of Use' functionality aiding tool familiarity
- 3,000 reading memory, time and date stamped
- Clear indication of successful joint application
- USB and Bluetooth® 4.0 data transfer (also called Bluetooth® Smart)
- 12 user IDs can be downloaded to the tool and results can be stored against individual users
- 20 unique stand-alone targets plus 20 unique work group targets for each work group
- Supplied with a traceable calibration certificate for torque & angle as standard. Calibrated from 20% to 100% of tools maximum torque capacity, clockwise only
- Software can be updated remotely, without the need to return the product to Norbar (a tool re-calibration will be required)
- Complimentary PC software 'EvoLog' for data management and tool configuration
- Display and on-board storage of final torque or torque and angle values
- Results can be output in CSV (comma-separated values) format for users not able to use EvoLog
- 'Usage' counter gives the ability to see the amount of times the tool has been used since the last reset
- 'Operation Direction' feature designed primarily for undoing bolts. When doing sequence tightening, it is possible to undo an incorrectly tightened bolt without interrupting the sequence
- 'Turn Angle' option can be used to check if bolts have already been tightened in an assembly process
- Allows tool integration into third party control systems
- Maximum Audit Mode target angle (720°)
- Available in single speed, ideal for all applications with a short bolt run-down and for torque with angle control
- Auto two speed configurations available for rapid joint completion